



TEX30LCD
TEX100LCD
TEX300LCD
TEX702LCD

TEX50LCD
TEX150LCD
TEX502LCD

USER MANUAL
VOLUME1



File Name: TEX30_50_100_150_300_502_702-LCD_ING_1.1.indb

Version: 1.1

Date: 15/11/2010

Revision History

Date	Version	Reason	Editor
30/07/2010	1.0	First Version	J. H. Berti
15/11/2010	1.1	Panel Card & PA Driver Stage Upgrades. TEX702LCD added.	J. H. Berti

TEX30LCD TEX50LCD TEX100LCD TEX150LCD TEX300LCD
TEX502LCD TEX702LCD - User Manual
Version 1.1

© Copyright 2010
R.V.R. Elettronica SpA
Via del Fonditore 2/2c - 40138 - Bologna (Italia)
Telephone: +39 051 6010506
Fax: +39 051 6011104
Email: info@rvr.it
Web: www.rvr.it

All rights reserved
Printed and bound in Italy. No part of this manual may be reproduced, memorized or transmitted in any form or by any means, electronic or mechanic, including photocopying, recording or by any information storage and retrieval system, without written permission of the

Notification of intended purpose and limitations of product use

This product is a FM transmitter intended for FM audio broadcasting. It utilises operating frequencies not harmonised in the intended countries of use.

The user must obtain a license before using the product in intended country of use. Ensure respective country licensing requirements are complied with.

Limitations of use can apply in respect of operating frequency, transmitter power and/or channel spacing.

Declaration of Conformity

Hereby, R.V.R. Elettronica SpA, declares that this FM transmitter is in compliance with the essential requirements and other relevant provisions of Directive 1999/5/EC.



Table of Contents

1.	Preliminary Instructions	1
2.	Warranty	1
3.	First Aid	2
3.1	Treatment of electrical shocks	2
3.2	Treatment of electrical Burns	2
4.	General Description	3
4.1	Unpacking	3
4.2	Features	3
4.3	Frontal Panel Description	5
4.4	Rear Panel Description	6
4.5	Connectors Description	7
4.6	Technical Description	9
5.	Quick guide for installation and use	10
5.1	Preparation	10
5.2	First power-on and setup	12
5.3	Operation	14
5.4	Management Firmware	16
5.5	Optional Function	22
6.	Identification and Access to the Modules	24
6.1	Identification of the Modules	24
7.	Working Principles	28
7.1	TEX30/50/00/50/300/502/702LCD Common Parts	28
7.2	TEX30LCD Different Parts	29
7.3	TEX50/100/50LCD Different Parts	30
7.4	TEX300LCD Different Parts	32
7.5	TEX502/702LCD Different Parts	33

This page was intentionally left blank

IMPORTANT



The symbol of lightning inside a triangle placed on the product, evidences the operations for which is necessary gave it full attention to avoid risk of electric shocks.



The symbol of exclamation mark inside a triangle placed on the product, informs the user about the presence of instructions inside the manual that accompanies the equipment, important for the efficacy and the maintenance (repairs).

1. Preliminary Instructions

• General Warnings

This equipment should only be operated, installed and maintained by "trained" or "qualified" personnel who are familiar with risks involved in working on electric and electronic circuits. "Trained" means personnel who have technical knowledge of equipment operation and who are responsible for their own safety and that of other unqualified personnel placed under their supervision when working on the equipment. "Qualified" means personnel who are trained in and experienced with equipment operation and who are responsible for their own safety and that of other unqualified personnel placed under their supervision when working on the equipment.

⚡ WARNING: Residual voltage may be present inside the equipment even when the ON/OFF switch is set to Off. Before servicing the equipment, disconnect the power cord or switch off the main power panel and make sure the safety earth connection is connected. Some service situations may require inspecting the equipment with live circuits. Only trained and qualified personnel may work on the equipment live and shall be assisted by a trained person who shall keep ready to disconnect power supply at need.

R.V.R. Elettronica S.p.A. shall not be liable for injury to persons or damage to property resulting from improper use or operation by trained/untrained and qualified/unqualified persons.

⚡ WARNING: The equipment is not water resistant. Any water entering the enclosure might impair proper operation. To prevent the risk of electrical shock or fire, do not expose this equipment to rain, dripping or moisture.

Please observe local codes and fire prevention rules when installing and operating this equipment.

⚡ WARNING: This equipment contains exposed live parts involving an electrical shock hazard. Always disconnect power supply before removing any covers or other parts of the equipment.

Ventilation slits and holes are provided to ensure reliable operation and prevent overheating; do not obstruct or cover these slits. Do not obstruct the ventilation slits under any circumstances. The product must not be incorporated in a rack unless adequate ventilation is provided or the manufacturer's instructions are followed closely.

⚠ WARNING: This equipment can radiate radiofrequency energy and, if not installed in compliance with manual instructions and applicable regulations, may cause interference with radio communications.

⚠ WARNING: This equipment is fitted with earth connections both in the power cord and for the chassis.

Make sure both are properly connected.

Operation of this equipment in a residential area may cause radio interference, in which case the user may be required to take adequate measures.

The specifications and data contained herein are provided for information only and are subject to changes without prior notice. R.V.R. Elettronica S.p.A. disclaims all warranties, express or implied. While R.V.R. Elettronica S.p.A. attempts to provide accurate information, it cannot accept responsibility or liability for any errors or inaccuracies in this manual, including the products and the software described herein. R.V.R. Elettronica S.p.A. reserves the right to make changes to equipment design and/or specifications and to this manual at any time without prior notice.

• Notice concerning product intended purpose and use limitations.

This product is a radio transmitter suitable for frequency-modulation audio radio broadcasting. Its operating frequencies are not harmonised in designated user countries. Before operating this equipment, user must obtain a licence to use radio spectrum from the competent authority in the designated user country. Operating frequency, transmitter power and other characteristics of the transmission system are subject to restrictions as specified in the licence.

2. Warranty

La R.V.R. Elettronica S.p.A. warrants this product to be free from defects in workmanship and its proper operation subject to the limitations set forth in the supplied Terms and Conditions. Please read the Terms and Conditions carefully, as purchase of the product or acceptance of the order acknowledgement imply acceptance of the Terms and Conditions. For the latest updated terms and conditions, please visit our web site at WWW.RVR.IT. The web site may be modified, removed or updated for any reason whatsoever without prior notice. The warranty will become null and void in the event the product enclosure is opened, the product is physically damaged, is repaired by unauthorised persons or is used for purposes other than its intended use, as well as in the event of improper use, unauthorised changes or neglect. In the event a defect is found, follow this procedure:

- 1 Contact the seller or distributor who sold the equipment; provide a description of the problem or malfunction for the event a quick fix is available.

Sellers and Distributors can provide the necessary information to troubleshoot the most frequently encountered problems. Normally, Sellers and Distributors can offer a faster repair service than the Manufacturer would. Please note that Sellers can pinpoint problems due to wrong installation.

- 2 If your Seller cannot help you, contact R.V.R. Elettronica S.p.A. and describe the problem; if our staff deems it appropriate, you will receive an authorisation to return the equipment along with suitable instructions;

- 3 When you have received the authorisation, you may return the unit. Pack the unit carefully before shipment; use the original packaging whenever possible and seal the package perfectly. The customer bears all risks of loss (i.e., R.V.R. shall not be liable for loss or damage) until the package reaches the R.V.R. factory. For this reason, we recommend insuring the goods for their full value. Returns must be sent on a C.I.F. basis (PREPAID) to the address stated on the authorisation as specified by the R.V.R. Service Manager.



Units returned without a return authorisation may be rejected and sent back to the sender.

- 4 Be sure to include a detailed report mentioning all problems you have found and copy of your original invoice (to show when the warranty period began) with the shipment.

Please send spare and warranty replacement parts orders to the address provided below. Make sure to specify equipment model and serial number, as well as part description and quantity.



R.V.R. Elettronica S.p.A.
Via del Fonditore, 2/2c
40138 BOLOGNA ITALY
Tel. +39 051 6010506

3. First Aid

All personnel engaged in equipment installation, operation and maintenance must be familiar with first aid procedures and routines.

3.1 Electric shock treatment

3.1.1 If the victim is unconscious

Follow the first aid procedures outlined below.

- Lay the victim down on his/her back on a firm surface.
- the neck and tilt the head backwards to free the airway system (**Figure 1**).

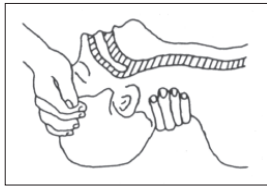

Figure 1

- If needed, open the victim's mouth and check for breathing.
- If there is no breathing, start artificial respiration without delay (**Figure 2**) as follows: tilt the head backwards, pinch the nostrils, seal your mouth around the victim's mouth and give four fast rescue breaths.



Figure 2

- Check for heartbeat (**Figure 3**); if there is no heartbeat, begin chest compressions immediately (**Figure 4**) placing your hands in the centre of the victim's chest (**Figure 5**).

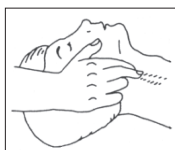

Figure 3

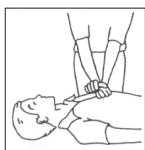

Figure 4

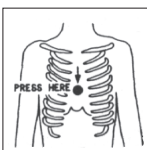

Figure 5

- One rescuer: give 2 quick rescue breaths after each 15 compressions.
- Two rescuers: one rescue breath after each 5 compressions.

- Do not stop chest compressions while giving artificial breathing.
- Call for medical help as soon as possible.

3.1.2 If the victim is conscious

- Cover victim with a blanket.
- Try to reassure the victim.
- Loosen the victim's clothing and have him/her lie down.
- Call for medical help as soon as possible.

3.2 Treatment of electric burns

3.2.1 Large burns and broken skin

- Cover affected area with a clean cloth or linen.
- Do not break any blisters that have formed; remove any clothing or fabric that is stuck to the skin; apply adequate ointment.
- Administer adequate treatment for the type of accident.
- Get the victim to a hospital as quickly as possible.
- Elevate arms and legs if injured.

If medical help is not available within an hour, the victim is conscious and is not retching, administer a solution of table salt and baking soda (one teaspoon of table salt to half teaspoon of baking soda every 250 ml of water).

Have the victim slowly drink half a glass of solution for four times during a period of 15 minutes.

Stop at the first sign of retching.

Do not administer alcoholic beverages.

3.2.2 Minor burns

- Apply cold (not ice cold) strips of gauze or dress wound with clean cloth.
- Do not break any blisters that have formed; remove any clothing or fabric that is stuck to the skin; apply adequate ointment.
- If needed, have the victim change into clean, dry clothing.
- Administer adequate treatment for the type of accident.
- Get the victim to a hospital as quickly as possible.
- Elevate arms and legs if injured.

4. General Description

The **TEX30/50/100/150/300/502/702LCD**, manufactured by **R.V.R. Elettronica SpA**, are **exciters for Frequency Modulated audio broadcasting** in a frequency modulation able to transmit in the band between 87.5 and 108 MHz, in step of 10 KHz, with an RF output power adjustable up to a maximum of 30, 50, 100, 150, 300, 500 and 700 W respectively into a 50 Ohm standard load.

The **TEX30/50/100/150/300/502/702LCD** are designed to being contained into a 19" rack box of 2HE.

4.1 Unpacking

The package contains:

- 1 **TEX30LCD, TEX50LCD, TEX100LCD, TEX150LCD, TE300LCD, TEX502LCD** or **TEX702LCD**
- 1 User Manual
- 1 Mains power cables

The following accessories are also available from Your R.V.R. Dealer:

- **Accessories, spare parts and cables**

4.2 Features

These exciters contain a low-pass filter that reduces the harmonic emission to provided for by international standards (CCIR, FCC or ETSI) and can be connected directly to the antenna.

Two major features of **TEX30/50/100/150/300/502/702LCD** are compact design and user-friendliness. Design is based on a modular concept: the different functions are performed by modules that, for the most part, are connected through male and facilitates maintenance and module replacement.

The RF power section of the **TEX30LCD** features a MOSFET module delivering up to 30W output power, the **TEX50/100/150LCD** features a MOSFET module delivering up to 150W output power, the **TEX300LCD** features a MOSFET module delivering up to 300W output power, whereas the **TEX502LCD** features two MOSFET modules with up to 350 W output power each; the **TEX702LCD** features a MOSFET module delivering up to 800W output power

Operating frequency stability is ensured by a temperature-compensated reference oscillator and is maintained by a PLL (Phase Locked Loop) system. The exciters will go into frequency lock within 30 seconds after power-on.



The **TEX30/50/100/150/300/502/702LCD** can operate throughout the frequency bank with no need for calibration or set-up.

An LCD on the front panel and a push-button board provide for user interfacing with the microprocessor control system, which offers the following features:

- Output power setup.
- Operating frequency setup.
- Power output enable/disable.
- Power Good feature (User-selectable output power alarm threshold).
- Measurement and display of transmitter operating parameters.
- Communication with external devices such as programming or telemetry systems via RS232 serial interface or I²C.

Four LEDs on the front panel provide the following status indications: **ON**, **LOCK**, **FOLDBACK** and **RF MUTE**.



The exciters have an input for the external 24 Vcc supply. This auxiliary supply source, that can be realized by the user with the help of rescue batteries, is automatically used in case of AC voltage absence.

The exciter management firmware is based on a menu system. User has four navigation buttons available to browse submenus: **ESC** ,  ,  ,  , ed **ENTER**.

The rear panel features the mains input connectors, as well as audio input connectors and RF output connector, telemetry connector, protection fuses and two inputs for signals modulated onto subcarriers by suitable external coders, such as RDS (Radio Data System) signals commonly used in Europe.

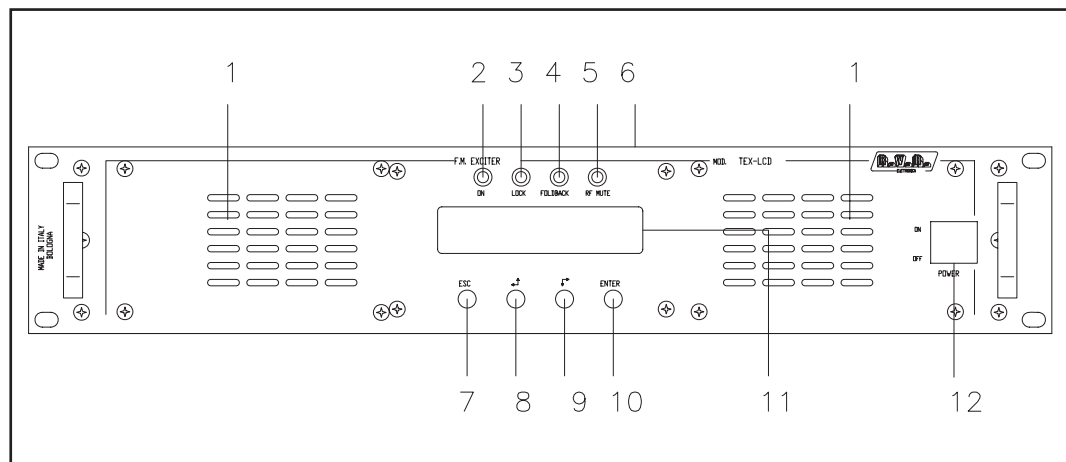
4.3 Frontal Panel Description



- | | |
|---|--|
| [1] AIR FLOW | Air flow for the forced ventilation. |
| [2] ON | Green LED, lit when the exciter is working. |
| [3] LOCK | Green led, lit when the PLL is locked on the working frequency. |
| [4] FOLDBACK | Yellow LED, lit when the foldback function is operating (automatic reduction of the delivered RF power). |
| [5] R.F. MUTE | Yellow LED, lit when the exciter's power output is inhibited by an external interlock command. |
| [6] CONTRAST | Display contrast adjusting trimmer (on the top of the equipment). |
| [7] ESC | Push button to exit from a menu. |
| [8]  | Push button to move in the menu system and to modify the parameters. |
| [9]  | Push button to move in the menu system and to modify the parameters. |
| [10] ENTER | Push button to confirm a parameter and to enter in a menu. |
| [11] DISPLAY | Liquid crystals display. |
| [12] POWER | ON/OFF switch. |

4.4 Rear Panel Description

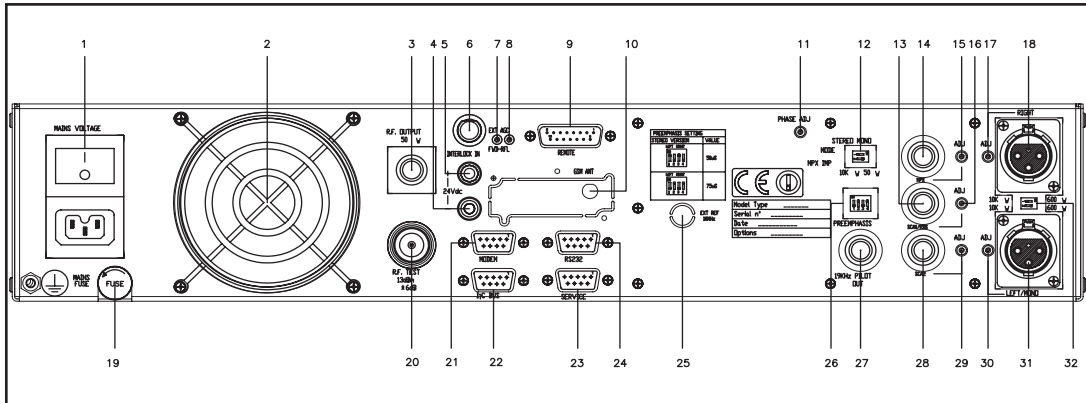

- [1] PLUG
 - [2] VENTOLA
 - [3] R.F. OUTPUT
 - [4] 24 VDC IN-
 - [5] 24 VDC IN-
 - [6] INTERLOCK OUT
 - [7] FWD EXT. AGC
 - [8] RFL EXT. AGC
 - [9] REMOTE
 - [10] GSM ANT
 - [11] PHASE ADJ
 - [12] MODE/MPX IMP
 - [13] SCA/RDS
 - [14] MPX
 - [15] MPX ADJ
 - [16] SCA/RDS ADJ
 - [17] RIGHT ADJ
 - [18] RIGHT
 - [19] FUSE BLOCK
 - [20] R.F. TEST
 - [21] MODEM
 - [22] I²C BUS
 - [23] RS232
 - [24] SERVICE
 - [25] EXT REF 10MHz
 - [26] PREEMPHASIS
- VDE plug for mains supply.
 Fan for the forced ventilation of the exciter.
 RF output connector, N-type, 50Ω.
 External 24Vdc supply input. Negative (black). Only for TEX30/50/100/150LCD.
 External 24Vdc supply input. Positive (red). Only for TEX30/50/100/150LCD.
 Connettore BNC di interlock in uscita: quando l'eccitatore entra in modalità stand-by, il conduttore centrale, normalmente flottante, viene posto a massa
 Trimmer for the control of the delivered power in function of the FWD fold input.
 Trimmer for the control of the delivered power in function of the RFL fold input.
 DB15 connector for telemetry of the machine.
 Reserved for Future Uses - SMA connector for GSM Antenna.
 Pilot tone phase adjustment trimmer.
 Dip-switch to set the operation mode (STEREO or MONO) and the MPX input impedance, 50Ω or 10kΩ.
 BNC connector, SCA/RDS unbalanced input.
 BNC connector, MPX unbalanced input.
 Adjustment trimmer for MPX input.
 Adjustment trimmer for SCA/RDS input.
 Adjustment trimmer for the Right channel input.
 XLR connector, balanced Right channel input.
 Fuse carrier. Use a screwdriver to access the fuse.
 RF test output, approx. 13 dBm wrt the RF output power level. Not suitable for spectral analysis.
 DB9 connector connected to GSM modem (only with telemetry option).
 Normally not used, or used for customized functions (only with telemetry option).
 DB9 connector for direct serial communication or modem (only with telemetry option).
 DB9 connector for interconnection with other devices and for factory parameters programming (only for factory programming).
 Fine regulation trimmer for frequency transmission.
 Optionally, Sync signal input BNC connector for external devices.
 Dip-switch to set the preemphasis at 50 or 75 μs. The preemphasis setting is relevant only for the Left and Right inputs in stereo mode and for the mono input in mono mode,

[27] 19 kHz PILOT OUT

[28] SCA2

[29] SCA2 ADJ

[30] LEFT-MONO ADJ

[31] LEFT-MONO

[32] IMPEDANCE

while MPX input is unaffected by this setting.
 BNC output for the 19 kHz pilot tone. This can be used for external devices (e.g. RDS coders) synchronization.
 BNC connector, SCA2 unbalanced input.
 Adjustment trimmer for SCA2 input.
 Adjustment trimmer for Left-Mono channel input.
 XLR connector, balanced Left-Mono channel input.
 Dip-switch to set the balanced input impedance, 600Ω or 10kΩ.

4.5 Connectors Description

4.5.1 RS232

Type: Female DB9

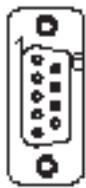

- 1 NC
- 2 SDA
- 3 SCL
- 4 NC
- 5 GND
- 6 NC
- 7 NC
- 8 NC
- 9 NC

4.5.2 Service (for programming of factory parameters)

Type: Female DB9



- 1 NC
- 2 TX_D
- 3 RX_D
- 4 Internally connected with 6
- 5 GND
- 6 Internally connected with 4
- 7 Internally connected with 8
- 8 Internally connected with 7
- 9 NC

4.5.3 I²C Bus

Type: Male DB9



- 1 NC
- 2 TX_D
- 3 RX_D
- 4 Internally connected with 6
- 5 GND
- 6 Internally connected with 4
- 7 Internally connected with 8
- 8 Internally connected with 7
- 9 NC

4.5.4 Left (MONO) / Right
Type: Female XLR



- 1 GND
- 2 Positive
- 3 Negative

4.5.5 Remote
Type: Female DB15



Pin	Name	Type	Meaning
1	Interlock	IN	By passes power if closed at GND
2	Ext AGC FWD	IN	Ext. signal, 1-12V, for power limitation (AGC)
3	GND		Ground
4	SDA IIC	I/O	IIC communication serial data
5	VPA TIm	ANL OUT	PA power supply voltage 3,9V F.S.
6	FWD TIm	ANL OUT	Forward power 3,9V F.S.
7	Power Good	DIG OUT	Open collector, enabled when power exceeds the set threshold
8	GND		Ground
9	GND		Ground
10	Ext AGC RFL	IN	Ext. signal., 1-12V, for power limitation (AGC)
11	SCL IIC	I/O	IIC communication clock
12	IPA TIm	ANL OUT	PA power supply current 3,9V F.S.
13	RFL TIm	ANL OUT	Reflected power 3,9V F.S.
14	On cmd	DIG IN	One grounded pulse (500 ms) enables power supply
15	OFF cmd	DIG IN	One grounded pulse (500 ms) disables power supply

4.6 Technical Description

Parameters	TEX30LCD	TEX50LCD	TEX100LCD	TEX150LCD	TEX300LCD	TEX502LCD	TEX702LCD
GENERALS							
Rated output power	30W	50W	100W	150W	300W	500W	700W
Frequency range	FCC -CCIR - OIRT - JPN						
Operational Mode	Mono, Stereo, Multiplex						
Modulation type	F3E						
Primary Power	80 ÷ 260 Vac or 24	115 / 230 ±15% or 28 Vdc				80 ÷ 260 Vac	
AC Power Consumption	130 VA / 70W	200 VA / 100W	330 VA / 212 W	440 VA / 260 W	560 VA / 520 W	970VA / 940W	1280VA / 1240W
Physical Dimensions (W x H x D)	483 x 88 x 394 mm						
Weight	7 kg	8,5 kg	8,5 kg	8,5 kg	9,5 kg	10 kg	10 kg
Environmental Working Conditions	-10 ÷ +50 °C / 95% relative Humidity non condensing						
Cooling	Forced, with internal fan						
Frequency programmability	From software, with 10 kHz steps						
Frequency stability	±1 ppm						
Pre-emphasis mode	0/50 (CCIR) µS, 75 (FCC) µS						
Spurious & harmonic suppression	<75 dBc (80 typical)						
Asynchronous AM S/N ratio	≥ 65 dB (typical 70)	≥ 60 dB (typical 68)			≥ 60 dB (typical 65)		
Synchronous AM S/N ratio	≥ 50 dB (typical 60)	≥ 50 dB (typical 58)			≥ 50 dB (typical 55)		
MONO OPERATION							
S/N FM Ratio	> 80 dB RMS (typical 85 dB)						
Frequency Response	< ± 0.5 dB 30Hz ÷ 15kHz (typical ± 0.2 dB)						
Total Harmonic Distortion	< 0.1 % 30 Hz ÷ 15 kHz (typical 0.07 %)						
Intermodulation distortion	< 0.02 % with 1 kHz and 1,3 kHz tones						
MPX OPERATION							
Composite S/N FM Ratio	> 80 dB RMS (typical 85 dB)						
Frequency Response	± 0.2 dB 30Hz ÷ 53kHz / ± 0.5 dB 53kHz ÷ 100 kHz						
Total Harmonic Distortion	< 0.1% 30Hz ÷ 53kHz						
Intermodulation distortion	< 0.05% with 1 kHz and 1,3 kHz tones						
INTERNAL STEREO CODER OPERATION							
Stereo S/N FM Ratio	> 75 dB RMS (typical 78dB)						
Frequency Response	± 0.5 dB 30 Hz ÷ 15 kHz						
Total Harmonic Distortion	< 0.05% 30 Hz ÷ 15 kHz						
Intermodulation distortion	≤ 0.03% with 1 kHz and 1,3 kHz tones						
Stereo separation	> 50 dB 30 Hz ÷ 15 kHz (typical 55 dB)						
AUDIO INPUT CONNECTORS							
Left / Right	XLR balanced; Impedance: 10 k or 600 ohm; Level: -13 to +13 dBu						
MPX unbalanced/RDS	BNC unbalanced; Impedance: 10 k or 50 ohm; Level: -13 to +13 dBu						
SCA/RDS	2 x BNC unbalanced; Impedance: 10 k; Level: -8 to +13 dBu						
OTHER CONNECTORS							
RF Output	N (50 ohm)						
RF Monitor	BNC (- 30dB referred to RF output)						
Pilot output	BNC (1Vpp)						
Interlock Input	BNC						
STANDARD COMPLIANCE							
Safety	EN 60215:1989 EN60215/A1:1992-07 EN60215/A2:1994-09						
EMC	EN 301 489-1 V1.4.1 (2002-08) EN 301 489-11 V1.2.1 (2002-11)						
Radio	EN 302 018-2 V1.2.1 (2005-06)						

5. Quick guide for installation and use

This section provides a step-by-step description of equipment installation and configuration procedure. Follow these procedures closely upon first power-on and each time any change is made to general configuration, such as when a new transmission station is added or the equipment is replaced.

Once the desired configuration has been set up, no more settings are required for normal operation; at each power-up (even after an accidental shutdown), the equipment defaults to the parameters set during the initial configuration procedure.

The topics covered in this section are discussed at greater length in the next sections, with detailed descriptions of all hardware and firmware features and capabilities. Please see the relevant sections for additional details.



IMPORTANT: *When configuring and testing the transmitter in which the equipment is integrated, be sure to have the Final Test Table supplied with the equipment ready at hand throughout the whole procedure; the Final Test Table lists all operating parameters as set and tested at the factory.*

5.1 Preapation

5.1.1 Preliminary checks

Unpack the exciter and immediately inspect it for transport damage. Ensure that all connectors are in perfect condition.

The main fuse can be accessed from the outside on the rear panel. Extract the fuse carrier with a screwdriver to check its integrity or for replacement, if necessary. The fuse to be used is this type:

	Fusibile principale
TEX30LCD @ 90÷260 Vac	(1x) 3.15A tipo 5x20
TEX50/100/150LCD @ 230 Vac/115 Vac	(1x) 6.3A tipo 5x20
TEX300/502/702LCD @ 230 Vac/115 Vac	(1x) 8A tipo 5x20

Table 5.1: Fuses

Provide for the following (applicable to operating tests and putting into service):

- √ Single-phase 230 VAC or 115 VAC (-15% / +10%) mains power supply for **TEX50/100/150LCD**, or 80÷260 VAC full-range mains power supply for **TEX30/300/502/702LCD**, with adequate earth connection.
- √ For operating tests only: dummy load with 50 Ohm impedance and adequate

capacity (30W for **TEX30LCD**, 50W for **TEX50LCD**, 100W for **TEX100LCD**, 150W for **TEX150LCD**, 300W for **TEX300LCD**, 500W for **TEX502LCD** or 700W for **TEX702LCD** as a minimum).

- √ Connection cable kit including:
 - Mains power cable
 - Coaxial cable with BNC connectors for interlock signal connection
 - RF cable for output to load / antenna (50 Ohm coaxial cable with N-type connector)
 - Audio cables between transmitter and audio sources.

5.1.2 Connections

Connect the RF output of the transmitter to the antenna cable or a dummy load capable of dissipating amplifier output power. To begin with, set exciter to minimum output power and switch it off.

Connect the transmitter INTERLOCK IN input to the matching INTERLOCK OUT output fitted on R.V.R. Elettronica equipment to act as hybrid couplers. If your equipment is a different brand, identify an equivalent output.

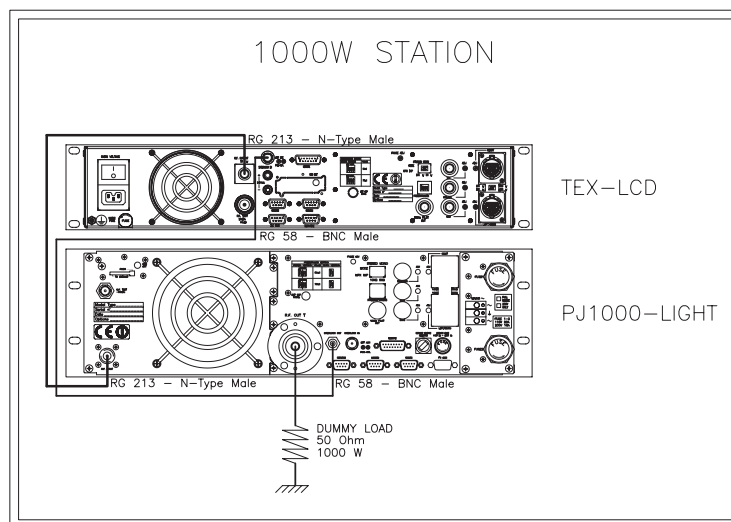

Figure 5.2: connections with amplifier



WARNING: Electric shock hazard! Never handle the RF output connector when the equipment is powered on and no load is connected. Injury or death may result.

Ensure that the POWER switch on the front panel of **TEX30/50/100/150/300/502/702LCD** is set to "OFF".

The exciter has two switches: one is embedded in VDE socket for mains power cord and interrupts all mains power supply of the machine, while the second is on the front panel and acts by inhibiting the switching power supply of the machine.

Connect the mains power cable to the MAINS connector on the rear panel.



Note: *the mains must be equipped with adequate earth connection properly connected to the equipment. This is a pre-requisite for ensuring operator safety and correct operation.*

Connect the audio and RDS/SCA signals from user's sources to the transmitter input connectors.

5.2 First power-on and setup

Seguire le istruzioni riportate di seguito nel caso di prima accensione o dopo aver effettuato un cambiamento alla configurazione dell'eccitatore nel quale questo componente è integrato.



Note : *Standard factory settings are RF output power off (**Pwr OFF**) and regulated output power set to upper limit (unless otherwise specified by customer).*

5.2.1 Power-on

When you have performed all of the connections described in the previous paragraph, power on the exciter using the suitable power switch on the front panel.

5.2.2 Power check

Ensure that the **ON** LED turns on. Equipment name should appear briefly on the display, followed by forward power and modulation readings. If the RF output is disabled, those readings will be zero.

When the PLL locks to operating frequency, the LOCK LED will turn on.

5.2.3 How to enable the RF output

Check output power level and set it to maximum level (unless it has already been set) from the Power Setup menu that you will have accessed by pressing the following sequence of key: ESC (opens Default Menu) ⇒ ENTER (hold down for 2 seconds) ⇒ SET ⇒ use keys to set bar to upper limit (figure 5.2 - menu 2).

Check the state of the **Pwr** output power by the **Fnc** menu. If it is set to **OFF**, press **ENTER** to bring the selection to **ON**.



5.2.4 Controllo del livello di potenza di uscita



Note: *The exciter incorporates Automatic Gain Control (AGC) and output power is modulated based on the power level set by the user and actual operating conditions, such as temperature, reflected power and other parameters. Please read section 5.3 for more details of RF power modulation.*

Access the **Power Setup Menu** pressing the following keys in the order:

ESC (opens **Default Menu**) ⇒ **ENTER** (hold down for 2 seconds)

Use the keys  and  in the **SET** menu to set exciter output power; the setting bar at the side of **SET** provides a graphic indication of power setting; please consider that the forward power readout provided on the display (**FWD: xxxx W**) reflects actual output power reading, **which may be lower than regulated power supply when Automatic Gain Control is running in power supply limitation mode** (please read section 5.3 about RF power supply modulation for more details).



Note: *Output power may be set using the **Pwr OFF** control. In this condition, the output power readout (**Fwd**) on the display will read 0 (zero); the **SET** bar will reflect any adjustments you make using the keys and provides a graphic indication of how much power supply will be delivered the moment you return to **Pwr On** state.*

5.2.5 Changing the *Power Good* alarm threshold

Change Forward Power Good alarm setting **PgD** from the **Fnc** menu as desired (factory setting is 50%).

5.2.6 Setting equipment I²C address

Change the **IIC** address in the **MIX** (Miscellaneous) menu as desired (factory setting is 01).

5.2.7 Adjustments and calibration

The only manual adjustments are the level adjustments and the audio mode adjustment.

The rear panel holds the trimmers for all exciter inputs. Trimmer identification is printed on the rear panel. Input sensitivity can be set within the limits set out in the tables below through the trimmers:

Input sensitivity:

Input	Figure 6.2	Trimmer	Sensitivity	Notes
SCA1/ RDS	[13]	[16]	- 8 ÷ +13 dBu	Input level for 7,5 kHz overall deviation (- 20 dB)
SCA2	[28]	[29]	- 8 ÷ +13 dBu	
MPX	[14]	[15]	-13 ÷ +13 dBu	Input level for 75 kHz overall deviation (0 dB)
Left/ Mono	[31]	[30]	-13 ÷ +13 dBu	
Right	[18]	[17]	-13 ÷ +13 dBu	

When setting input sensitivity, please consider that the default menu reports instantaneous modulation level and an indicator provides a 75 kHz reading. To ensure correct adjustment, apply a signal with the same level as user’s audio broadcast maximum level and then adjust using the trimmer until instantaneous deviation matches the 75 kHz reading.

To set subcarrier input levels, you may use the same procedure and option “x10” available in the **Fnc** menu. With this option, modulation level is multiplied by a factor of 10, which means that default menu bar meter reflects a 7.5 kHz deviation.

A special menu with separate indications of Left and Right channel levels and relating indicators of nominal levels for maximum deviation (75 kHz) is provided.

- Preemphasis:



- L and R (XLR type) input impedance:



Switch 1: R XLR input impedance, ON = 600 Ω, OFF = 10 kΩ

Switch 2: L XLR input impedance, ON = 600 Ω, OFF = 10 kΩ

- MPX input operation mode/impedance:



Switch 1: Mode of operation ON = Mono, OFF = Stereo

Switch 2: MPX input impedance, ON = 50 Ω, OFF = 10 kΩ

5.3 Operation



NOTE: For better clarity, only the typical screens of **TEX702LCD** are reported below. **TEX30/50/100/150/300/502LCD** screens look the same except that full scale values are different.

- 1) Power on the exciter and ensure that the **ON** light turns on. Equipment name should appear briefly on the display, quickly followed by modulation and forward power readings (Menu 1), provided that the exciter is delivering output power.



Menu 1

1b) To **modify power level setting**, hold down the **ENTER** button until opening the **power setup menu**.



The edit screen will look like this:



Menu 2

Next to **SET** indication, a bar provides a graphic display of preset output power. The filled portion of the bar is proportional to set power level.

Example		
100% potenza di uscita	Barra piena	<p>≅ 700W in uscita (mod.TEX702LCD)</p> <p>≅ 500W in uscita (mod.TEX502LCD)</p> <p>≅ 300W in uscita (mod.TEX300LCD)</p> <p>≅ 150W in uscita (mod.TEX150LCD)</p> <p>≅ 100W in uscita (mod.TEX100LCD)</p> <p>≅ 50W in uscita (mod.TEX50LCD)</p> <p>≅ 30W in uscita (mod.TEX30LCD)</p>
25% potenza di uscita	1/4 della barra	<p>≅ 175W in uscita (mod.TEX702LCD)</p> <p>≅ 125W in uscita (mod.TEX502LCD)</p> <p>≅ 75W in uscita (mod.TEX300LCD)</p> <p>≅ 700W in uscita (mod.TEX702LCD)</p> <p>≅ 37,5W in uscita (mod.TEX150LCD)</p> <p>≅ 25W in uscita (mod.TEX100LCD)</p> <p>≅ 12,5W in uscita (mod.TEX50LCD)</p> <p>≅ 7,5W in uscita (mod.TEX30LCD)</p>

The bottom line provides instantaneous power reading (700W for **TEX702LCD** shown here), press button  to increase level, press  to decrease it. When you have achieved the desired level, press **ENTER** to confirm and exit the **default menu**. Please note that the setting is stored automatically; in other words, if you press ESC or do not press any keys before the preset time times out, the latest power level set will be retained.



NOTE: This feature prevents the equipment from delivering maximum power as soon as output is enabled from menu 4, or in the event the equipment is already set to **ON** when you energise it.

- 2) Ensure that the equipment is not in a locked-out state. Press **ESC** to call up the selection screen (menu 3). Highlight **Fnc** and press **ENTER** to confirm and access the selected menu (menu 4).

If **PWR** is set to OFF, i.e. power output is disabled, move cursor to **PWR**. Press **ENTER** and label will switch to ON, i.e. power output is enabled.

Press **ESC** twice to go back to the default menu (menu 1).

- 3) Fine tune power setting from menu 2 (see description of item 1b) until achieving the desired value.



WARNING: Equipment is capable of delivering more than rated output power (30/50/100/150/300/500/700 W for **TEX30/50/100/150/300/502/702LCD** respectively); however, never exceed the specified power rating.



NOTE: If power is set to 0 W in the **Power Setup Menu**, the INTERLOCK OUT contact is activated and any external appliances connected to it are immediately inhibited.

Next, you can review all operating parameters of the equipment through the management firmware.

Normally, the equipment can run unattended. Any alarm condition is handled automatically by the safety system or is signalled by the LED indicators on the panel or by display messages.



NOTE: Standard factory settings are output power set to upper limit (unless otherwise specified by customer) and **OFF**.

5.4 Management Firmware

The equipment features an LCD with two lines by 16 characters that displays a set of menus. The figure below provides an overview of equipment menus.

The symbols listed below appear in the left portion of the display as appropriate:

– (Cursor) - Highlights selected (i.e. accessible) menu.

▶ (Filled arrow) - Editable parameter marker. This symbol appears in menus that take up more than two lines to aid browsing.

▶▶▶ (Three empty arrows) - Parameter is being edited.

As soon as operating conditions are restored, power output is re-enabled with the same settings in use prior to the alarm condition.

Under 20kHz, no modulation occurs. After a preset time of about 5 minutes (not editable), a NO AUDIO condition is indicated in the main screen, but power is not inhibited.

```

Mod: NO AUDIO
Fwd:      0      W
    
```



State 2

To gain access to a submenu, select menu name (name is highlighted by cursor) using button or and press the **ENTER** button.

To return to the **default menu** (menu 1), simply press **ESC** again.

5.4.1 Operation Menu (Fnc)

In this menu, you can toggle exciter **power output** On/Off, set **deviation display mode** and the threshold rate for **Forward (PgD)** or **Reflected (PgR) Power Good**.

To edit an item, highlight the appropriate line using the  and  buttons and then press and hold the **ENTER** button until the command is accepted. This way, Pwr setting is toggled between On and Off and Mod setting is toggled between “x1” and “x10”. To edit the Power Good rate, simply select item “PgD” or “PgR” and edit its value using the UP and DOWN buttons; finally, press ENTER to confirm.

```

▶ Pwr: ON
  Mod: x10
  PgD:  50      %
  PgR:   5      %
    
```

Menu 4

Pwr Enables (ON) or disables (OFF) exciter power output.

Mod Modifies modulation display (toggles between “x1” and “x10”). In “x10” mode, instantaneous deviation indication is multiplied by a factor of 10, and the bar meter on the default menu will reflect 7.5 kHz instead of

75 kHz. This display mode is convenient when you wish to display low deviation levels, such as those caused by pilot tone or subcarriers.

PgD Modifies Power Good threshold for forward power. The Power Good rate is a percent of equipment rated power (30/50/100/150/300/500/702 W for **TEX30/50/100/150/300/502/702LCD** respectively), not of forward output power. This means that this threshold set at 50% will give 15/25/50/75/150/250/350 W, respectively, regardless of set power level. The Power Good feature enables output power control and reporting. When output power drops below set Power Good threshold, the equipment changes the state of pin [7] of the DB15 “Remote” connector located on the rear panel.

PgR Modifies Power Good threshold for reflected power. The Power Good rate is a percent of equipment rated power (3/5/10/15/30/50/70 W for **TEX30/50/100/150/300/502/702LCD** respectively), not of reflected output power. This means that this threshold set at 5% will give 0,15 /0,25/0,50/0,75/1,5/2,5/3,5 W , respectively, regardless of set power level. The Power Good feature enables output power control and alarm management.



NOTE: This alarm does not trip any contacts in the DB15 “Remote” connector and is only available in systems equipped with telemetry.

5.4.2 Power menu(Pwr)

This screen holds all readings related to equipment output power:

▷Fwd:	700	W
Rf1:	12	W



Menu 5

Fwd Forward power reading.

Rfl Reflected power reading.

Note that these are readings, rather than settings, and cannot be edited (note the empty triangle). To change power setting, go to the **default menu** as outlined earlier.

5.4.3 Power Amplifier (P.A) Menu

This screen is made up of four lines that can be scrolled using the  and  buttons and shows the readings relating to final power stage:

▶Vpa:	50.2	V
Ipa:	32.9	A
Eff:	57	%
Tmp:	27.8	°C

Menu 6

Note that these are readings, rather than settings, and cannot be edited (note the empty arrow).

- VPA Voltage supplied by amplifier module.
- IPA Current draw of amplifier module.
- Eff Efficiency based on ratio of forward power to amplifier module power, in percent (FWD PWR/(Vpa x Ipa) %).
- Tmp Equipment internal temperature reading.

5.4.4 Setup Menu (Set)

This menu lets you view and set operating frequency.

▶F1 :	98.00	MHz
-------	-------	-----

Menu 7

- F1 Operating frequency setup. Set a new frequency value and then press the **ENTER** button to confirm your selection; the exciter unlocks from current frequency (the **LOCK** LED turns off) and will lock to the new operating frequency (**LOCK** turns back on again).
If you press **ESC** or let the preset time time out, the previous frequency setting is retained.

5.4.5 Miscellaneous Menu (Mix)

This menu lets you set equipment address in an I²C bus serial connection:

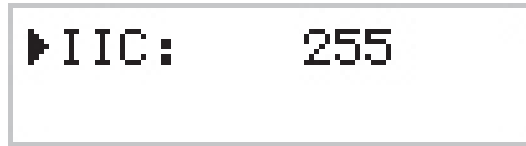

Menu 8

IIC I²C address setting. The I²C network address becomes significant when the exciter is connected in an RVR transmission system that uses this protocol. Do not change it unless strictly required.

5.4.6 Version Menu (Vrs)

This screen holds equipment version/release information:

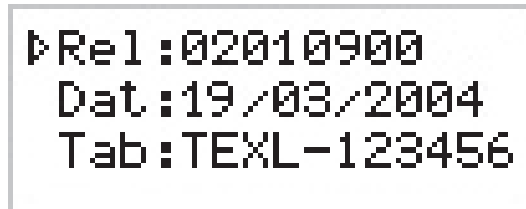

Menu 9

Note that these are readings, rather than settings, and cannot be edited (note the empty arrow).

- Re1 Firmware release information.
- Dat Release date.
- Tab Shows table loaded in the memory.

5.4.7 Channels Menu (L&R)

Right and left channel input levels are displayed as horizontal bars as shown in the figure below.

The bar meter reflects the level corresponding to a 100% deviation for each channel and provides a convenient reference when setting audio channel input levels.

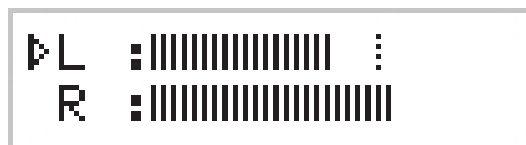

Menu 10

- L Left channel Vmeter.
- R Right channel Vmeter..

5.5 Optional Function

A range of options is available for the product to add certain functions and/or modify existing functions. Outlined below are the functions available at the moment, which must be specified on order.

5.5.1 FSK Option

The FSK function generates periodic carrier frequency shifts to generate a Morsecode station ID code.



NOTE: This function is typically used in the USA.

The factory setting for frequency shift is +10KHz and code repetition period is 60 minutes (please contact R.V.R. Elettronica if you need different settings), whereas station identified may be programmed by the user following the indications provided in section below.

When the FSK option is fitted, an FSK submenu is added to the **selection menu**.

```

Enc Pwr P.A Set
Mix Urs L&R FSK
    
```

Menu 11

Press the **ENTER** key when FSK is highlighted in the **selection menu** to access the FSK submenu:

```

▶ FSK:      ON
  Cod: 012345
    
```

Menu 12

FSK Enables / disables FSK code transmission.

Cod Shows the Morse code sent normally.

5.5.1.1 Changing the ID code

User may change the FSK code used as a station identifier at any time.

This procedure requires:

- 1 RS232 male-female cable;
- Hyper Terminal interface (make sure it has been installed together with Windows®) or equivalent serial communication software.

A brief description of the procedure is provided below:

- Connect the PC serial port COM to the SERVICE connector on the rear panel of **TEX30/50/100/150/300/502/702LCD** using a standard Male DB9 - Female DB9 serial cable.
- Power on the exciter;
- Launch the serial communication software;
- Set communication parameters as follows:

Baud Rate: 19200

Data Bit: 8

Parity: None

Stop Bit: 1

Flow control: None;

- Activate Caps-Lock through the communication software and send string CODE followed by the 6-character station ID code followed by Enter.



NOTE: To be treated as valid, the code must be made up of 6 alphanumeric characters and must contain no blank spaces; if acknowledged as valid, code is echoed back to the terminal, illegal codes are not echoed.

5.5.2 Power UP/DOWN Option

The Power UP/DOWN option modifies the signal receive function for the signals present at the telemetry connector.

RF section on / off control signals are treated as control signals for RF output power level to allow for UP/DOWN setting.

The UP or DOWN command is provided by switching the corresponding signal at the connector to ground for at least 500mS (pin features internal pull-up to power supply).

Configuration of DB15F telemetry connector (Remote):



Pin	Standard Function	UP/DOWN Power Function
14	On cmd <i>Enables the RF power supply</i>	Up cmd <i>Increases the RF power supply</i>
15	Off cmd <i>Disables the RF power supply</i>	Down cmd <i>Reduces the RF power supply</i>

6. Identification and Access to the Modules

6.1 Identification of the Modules

The **TEX30/50/100/150/300/502/702LCD** is made up of various modules linked to each other through connectors so as to make maintenance and any required module replacement easier.

6.1.1 TEX30LCD Upper view

The figure below shows the equipment upper view with the various components pointed out.

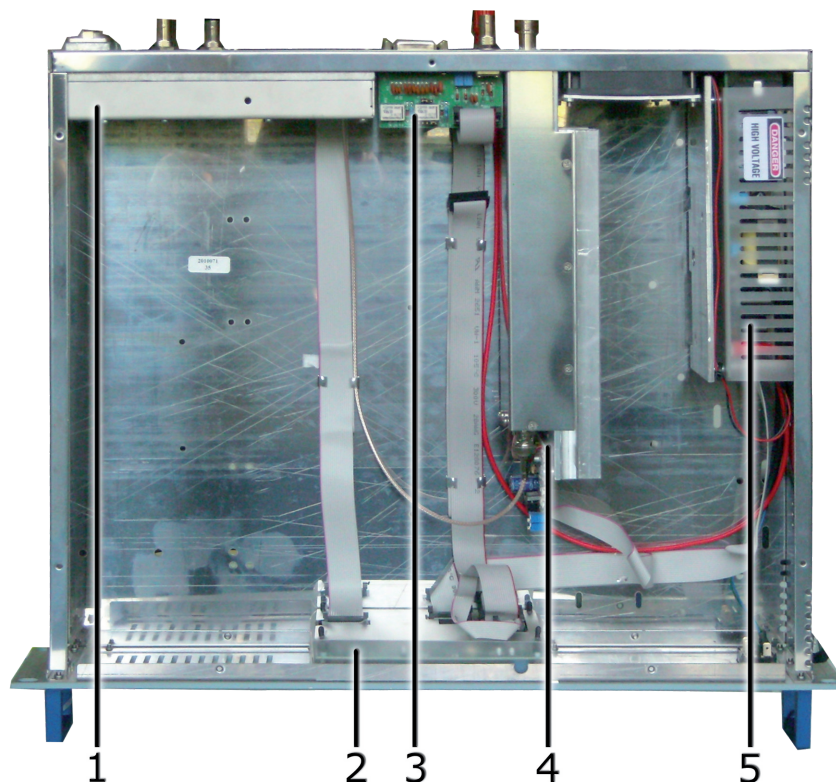

figure 8.1

- [1] Main Board & Stereo Coder Card (**SLMBDTEXLC07** & **SLCTC30V03**)
- [2] Panel Card (**SL007PC3001**)
- [3] Telemetry Card (**SLTLMTXLCD03**)
- [4] Control Card& Power Amplifier (**SL037BI1004** & **SLPA30WMOS02**)
- [5] Power Supply (**FLY100SMD**)

6.1.2 TEX50/100/150LCD Upper view

The figure below shows the equipment upper view with the various components pointed out.

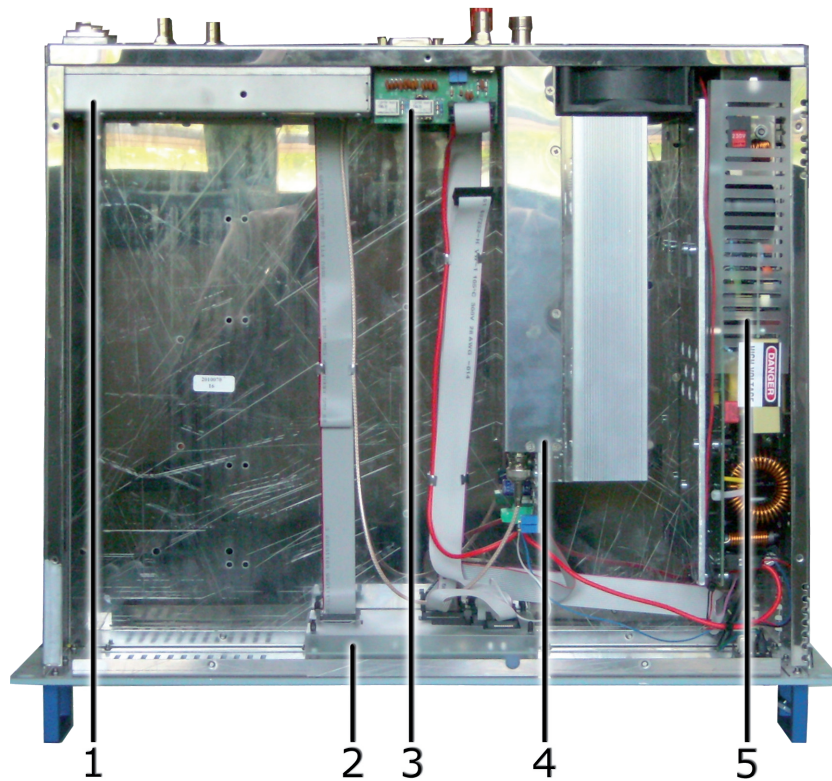

figure 8.2

- [1] Main Board & Stereo Coder Card (**SLMBDTEXLC07 & SLCTC30V03**)
- [2] Panel Card (**SL007PC3001**)
- [3] Telemetry Card (**SLTLMTXLCD03**)
- [4] Control Card & Power Amplifier (**SL045DR1003 & SLPA150WMOS**)
- [5] Power Supply (**PSL300**)

6.1.3 TEX300LCD Upper view

The figure below shows the equipment upper view with the various components pointed out.

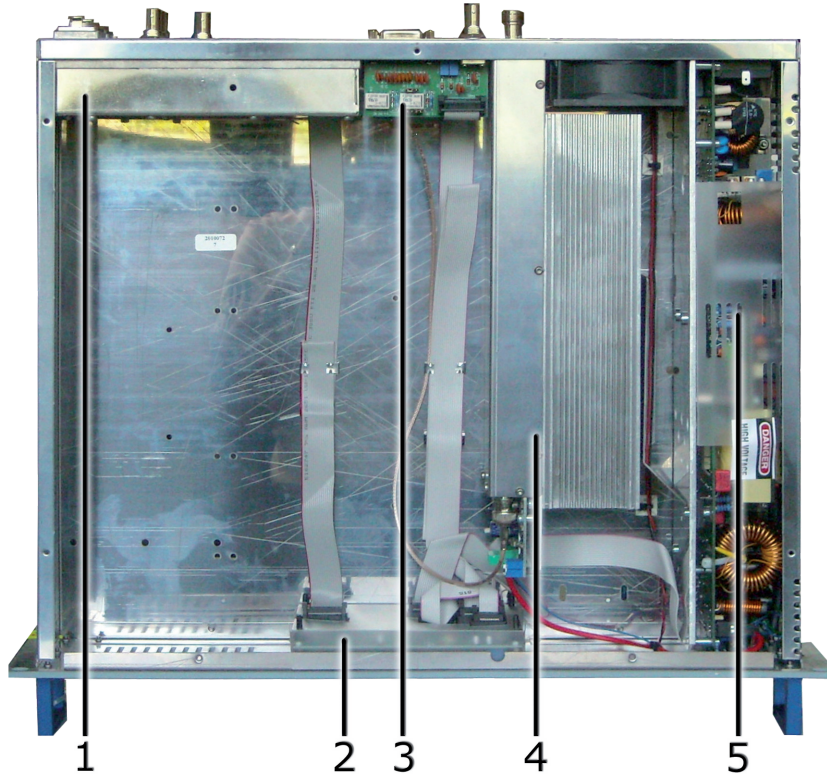

figure 8.3

- [1] Main Board & Stereo Coder Card (**SLMBDTEXLC07 & SLCTC30V03**)
- [2] Panel Card (**SL007PC3001**)
- [3] Telemetry Card (**SLTLMTXLCD03**)
- [4] Control Card & Power Amplifier (**SL045DR1003 & SL045RF1002**)
- [5] Power Supply (**PSL600**)

6.1.4 TEX502/702LCD Upper view

The figure below shows the equipment upper view with the various components pointed out.

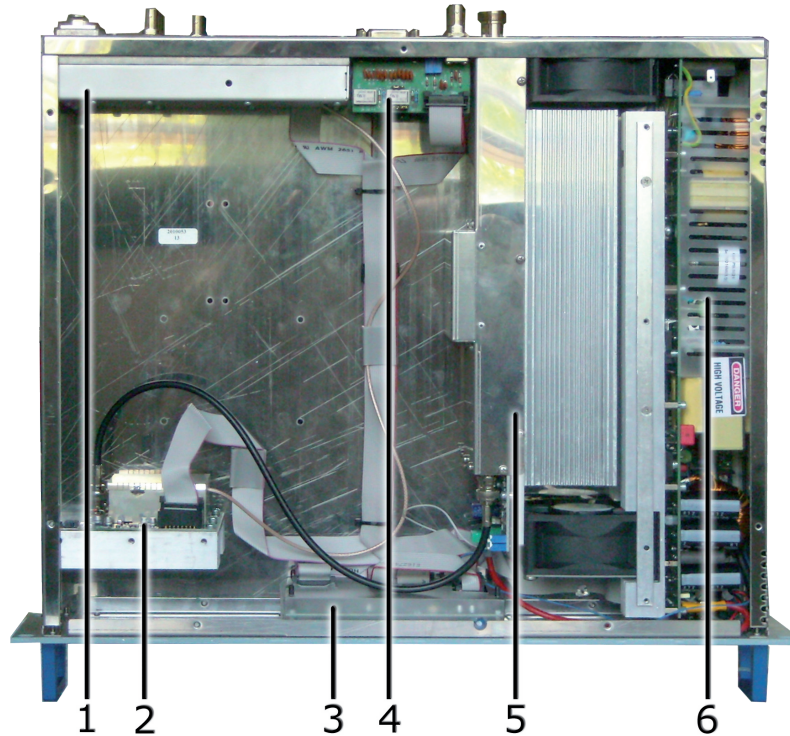

figure 8.4

- [1] Main Board & Stereo Coder Card (**SLMBDTEXLC07** & **SLCTC30V03**)
- [2] Driver Card (**SL175DR1002**)
- [3] Panel Card (**SL007PC3001**)
- [4] Telemetry Card (**SLTLMTXLCD03**)
- [5] Bias Card, Control Card, Low Pass Filter Card & Power Amplifier - **TEX502LCD** model (**SL046BI1001**, **SL175BI1001**, **SL175LP1002** & **SL154RF3001**)
Bias Card, Control Card, Low Pass Filter Card & Power Amplifier - **TEX702LCD** model (**SL046BI1001**, **SL175BI1001**, **SL175LP1002** & **SL154RF2002**)
- [6] Power Supply (**PSL5021**)

7. Working Principles

7.1 TEX30/50/100/150/300/502/702LCD Common Parts

7.1.1 Panel board

The panel board contains the microcontroller (PIC18F452) that implements the equipment control software, the display and the other components needed to interface with the user.

The board is connected with the other machine modules, both for power supply distribution and for the control and measures.

7.1.2 Main board

The main board carries out the following functions:

- Audio and SCA input treatment
- Generation of carrier frequency
- Modulation
- R.F. amplification (Driver)

The board also features a stereophonic coder.

7.1.2.1 Audio input section

The audio input section contains the circuits that perform the following functions:

- Input impedance selection
- 15 kHz filtering of the left and right channel
- Stereophonic Coding
- Mono channel preemphasis
- Mono, MPX and SCA channel mixing
- Clipper (limits the modulating signal level so that the frequency deviation does not exceed 75 kHz)
- Modulating signal measurement

7.1.2.2 PLL/VCO section

This board section generates the modulated radiofrequency signal. It is based on a PLL scheme that uses an integrated MB15E06 type.

7.1.2.3 Driver section

Before passing to the final power amplifier, the RF signal is preamplified in this

section by an ERA3 transistor. When the exciter is placed on stand-by, the driver is by-passed.

7.1.3 Telemetry board

This board is designed to inform the user of the equipment operation state. All input and output signals are available on the DB15 connector.

The same board also features the “INTERLOCK” BNC connector for disabling the device. By grounding the central pin, the output power is reduced to zero until the connection is removed.

When an R.V.R. amplifier is used, this connector is linked to the power amplifier REMOTE or INTERLOCK by means of a BNC-BNC connection. In case of amplifier faults, the central conductor is grounded thus forcing the machine to enter in stand-by mode.

7.2 TEX30LCD Different Parts

7.2.1 Power Supply

The **TEX30LCD** power supply unit is a switching-type unit whose +28 V main output powers the machine's RF amplifier. The power supply also features stabilizers for generating continuous +5 V and +18 V voltages for supplying the other equipment circuits. Note that the power supply is a “direct from mains” type, or rather it is without a transformer, and it can be connected to any voltage between 80 and 260 V without any adjustments or manual settings. The power supply unit is also connected to 24 V auxiliary continuous voltage inputs used to automatically buffer the mains power cutoff.

7.2.2 Power Amplifier

The final power stage is enclosed in a totally shielded metal container fastened in the centre of the device.

The RF signal coming from the “main” card reaches the pilot, is amplified and is then sent to the final stage that sees to its final amplifications up to 30W.

The amplifier is made in three stages. The first is made with one BFG35, the second with three BFG35 in parallel, and the last with one BLF245.

In addition to the actual RF amplification, this circuit carries out the following functions:

- Control of the power level in output, depending on the setting
- Reduction of the power supplied when in presence of high-level reflected power

- Measures of the forward and reflected power by means of directional couplers
- Measures of the current absorbed by the power amplifier
- Measures of the temperature
- Low-pass filtering of the RF signal in output

This board also features an RF sampling of approximately -30dB RF with respect to the output, which is available on a BNC connector below the transmitter output connector. This sample is useful for verifying the characteristics of the carrier, but not for verifying those of the upper harmonics.

7.2.3 Control Board

The main function of this board is to check and correct the MOSFET polarization voltage of the RF amplifier section.

It also provides the measurement of the absorbed current and contains a circuit for signaling power supply unit faults.

If no alarms are present, the voltage is adjusted only depending on the set output power, with a feedback mechanism based on the reading of the power really delivered (AGC).

The voltage is also affected by other factors, such as:

- Excess of reflected power.
- External AGC signals (Ext. AGC FWD, Ext. AGC RFL).
- Excess of temperature.
- Excess of absorbed current from the RF module.

7.3 TEX50/100/150LCD Different Parts

7.3.1 Power Supply

The **TEX50/100/150LCD** power supply unit is a switching-type unit whose +28 V main output powers the machine's RF amplifier. The power supply also features stabilizers for generating continuous +5 V, -15V, +8V, +18 V and -18 V voltages for powering the other device circuits. The power supply unit is also connected to 24 V auxiliary continuous voltage inputs used to automatically buffer the mains power cutoff.

7.3.2 Power Amplifier

The final power stage is enclosed in a totally shielded metal container fastened in the centre of the device.

The RF signal coming from the “main” card reaches the pilot, is amplified and is then sent to the final stage that sees to its final amplifications up to 150W.

The amplifier is made in two stages. The first is made with BLF244 and the last with BLF147.

In addition to the actual RF amplification, this circuit carries out the following functions:

- Control of the power level in output, depending on the setting
- Reduction of the power supplied when in presence of high-level reflected power
- Measures of the forward and reflected power by means of directional couplers
- Measures of the current absorbed by the power amplifier
- Measures of the temperature
- Low-pass filtering of the RF signal in output

On this card is an RF sample approximately -30dB compared with the output that is available on a BNC connector underneath the output connector of the transmitter. This sample is useful for checking the characteristics of the carrier, but not of the higher order harmonics.

7.3.3 Control Board

The main function of this board is to check and correct the MOSFET polarization voltage of the RF amplifier section.

It also provides the measurement of the absorbed current and contains a circuit for signaling power supply unit faults.

If no alarms are present, the voltage is adjusted only depending on the set output power, with a feedback mechanism based on the reading of the power really delivered (AGC).

The voltage is also affected by other factors, such as:

- Excess of reflected power.
- External AGC signals (Ext. AGC FWD, Ext. AGC RFL).
- Excess of temperature.
- Excess of absorbed current from the RF module.

7.4 TEX300LCD Different Parts

7.4.1 Power Supply

The **TEX300LCD** power supply unit is a switching-type unit whose +50 V main stabilizers for generating continuous +5 V, +18 V and -18 V voltages for supplying the other equipment circuits. Note that the power supply is a “direct from mains” type, or rather it is without a transformer, and it can be connected to any voltage between 90 and 260 V without any adjustments or manual settings.

7.4.2 Power Amplifier

The final power stage is enclosed in a totally shielded metal container fastened in the centre of the device.

The RF signal coming from the “main” card reaches the pilot, is amplified and is then sent to the final stage that sees to its final amplifications up to 300W.

The amplifier is made in three stages. The first is made with BFG35, the second with one BLF175 and the last with one SD2942.

In addition to the actual RF amplification, this circuit carries out the following functions:

- Control of the power level in output, depending on the setting
- Reduction of the power supplied when in presence of high-level reflected power
- Measures of the forward and reflected power by means of directional couplers
- Measures of the current absorbed by the power amplifier
- Measures of the temperature
- Low-pass filtering of the RF signal in output

This board also features an RF sampling of approximately -60dB RF with respect to the output, which is available on a BNC connector below the transmitter output connector. This sample is useful for verifying the characteristics of the carrier, but not for verifying those of the upper harmonics.

7.4.3 Control Board

The main function of this board is to check and correct the MOSFET polarization voltage of the RF amplifier section.

It also provides the measurement of the absorbed current and contains a circuit for signaling power supply unit faults.

If no alarms are present, the voltage is adjusted only depending on the set output

power, with a feedback mechanism based on the reading of the power really delivered (AGC).

The voltage is also affected by other factors, such as:

- Excess of reflected power.
- External AGC signals (Ext. AGC FWD, Ext. AGC RFL).
- Excess of temperature.
- Excess of absorbed current from the RF module.

7.5 TEX502/702LCD Different Parts

7.5.1 Power Supply

The **TEX502LCD** power supply unit is a switching-type unit whose +50 V main stabilizers for generating continuous +5 V, +18 V and -18 V voltages for supplying the other equipment circuits. Note that the power supply is a “direct from mains” type, or rather it is without a transformer, and it can be connected to any voltage between 90 and 260 V without any adjustments or manual settings.

7.5.2 Power Amplifier

The final power stage is enclosed in a totally shielded metal container fastened in the centre of the device.

The RF signal coming from the “main” card reaches the pilot, is amplified and is then sent to the final stage that sees to its final amplifications up to 500W (for **TEX502LCD** model) or up to 700W (for **TEX702LCD** model).

The amplification stage consists of two main blocks.

In addition to the actual RF amplification, this circuit carries out the following functions:

- Control of the power level in output, depending on the setting
- Reduction of the power supplied when in presence of high-level reflected power
- Measures of the current absorbed by the power amplifier
- Measures of the temperature

This board also features an RF sampling of approximately -60dB RF with respect to the output, which is available on a BNC connector below the transmitter output connector. This sample is useful for verifying the characteristics of the carrier, but not for verifying those of the upper harmonics.

7.5.2.1 Driver Stage block

The driver card is able to The card and drivers' capable of delivering approximately 15W of power.

The driver stage is made in two stages. The first is made with one BFG35 and the last with one LD-MOS PD57006.

7.5.2.2 Final Stage block

The final stage is made of two MOS-FET SD2932 (for **TEX502LCD** model) or two MOS-FET SD2942 (for **TEX702LCD** model).

7.5.3 Control Board

The main function of this board is to check and correct the MOSFET polarization voltage of the RF amplifier section.

It also provides the measurement of the absorbed current and contains a circuit for signaling power supply unit faults.

If no alarms are present, the voltage is adjusted only depending on the set output power, with a feedback mechanism based on the reading of the power really delivered (AGC).

The voltage is also affected by other factors, such as:

- Excess of reflected power.
- External AGC signals (Ext. AGC FWD, Ext. AGC RFL).
- Excess of temperature.
- Excess of absorbed current from the RF module.

7.5.4 Low Pass Filter Card

This card provide the low-pass filtering of the RF signal in output and measure the reflected and forward power output.

7.5.5 Bias Card

This card controls the bias voltage and contains AGC networks for forward power, reflected power, temperature, current and EXT AGC.

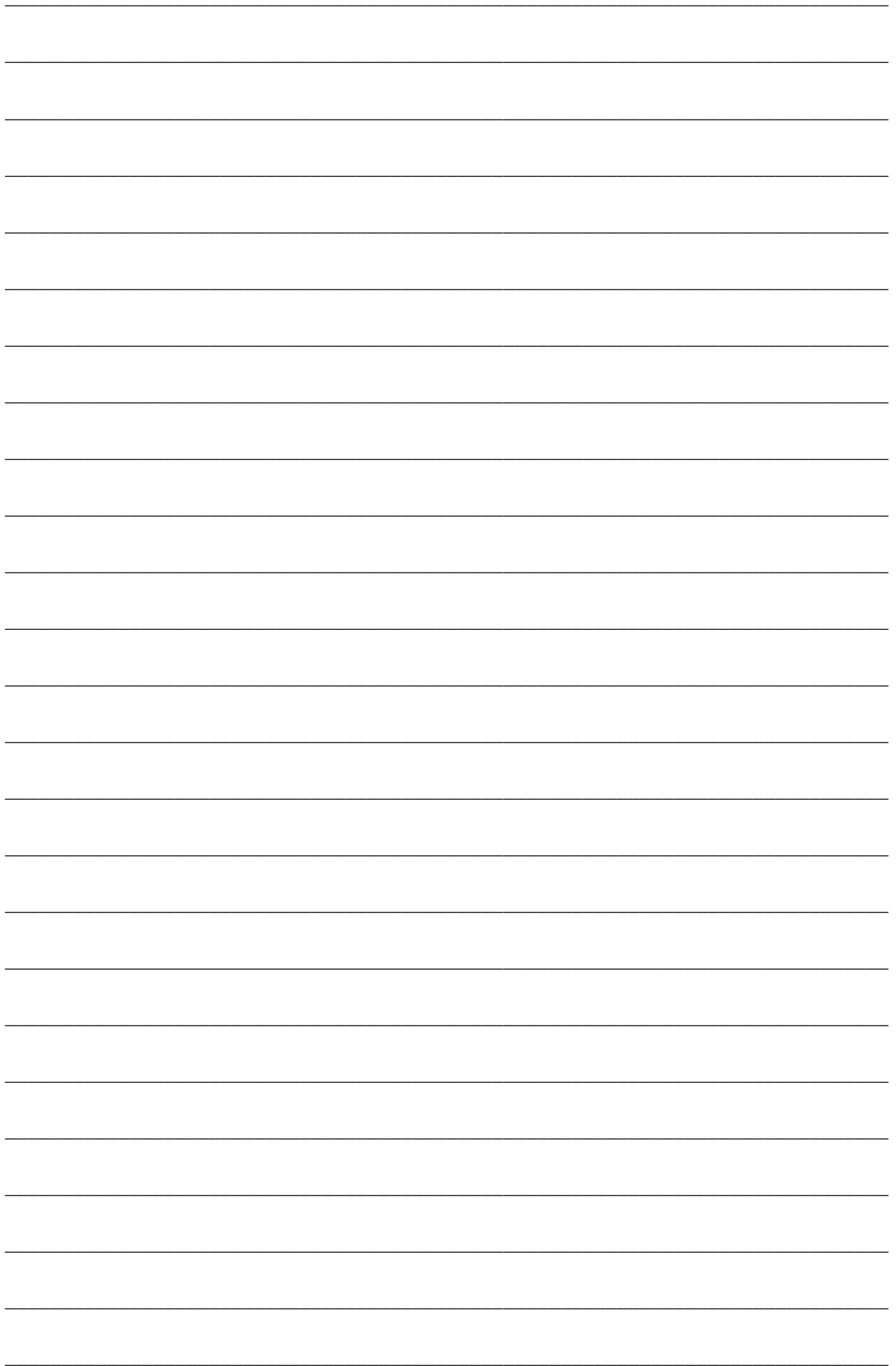



R.V.R. Elettronica S.p.A.

Via del Fonditore, 2 / 2c
Zona Industriale Roveri · 40138 Bologna · Italy
Phone: +39 051 6010506 · Fax: +39 051 6011104
e-mail: info@rvr.it · web: <http://www.rvr.it>

ISO 9001:2000 certified since 2000



The RVR Logo, and others referenced RVR products and services are trademarks of RVR Elettronica S.p.A. in Italy, other countries or both. RVR ® 1998 all rights reserved.
All other trademarks, trade names or logos used are property of their respective owners.